

Y322L - Y322A

MFOM Terminals - Terminals for printed circuits - 5 x 0,8

 Buy this product online

www.mfom.fr

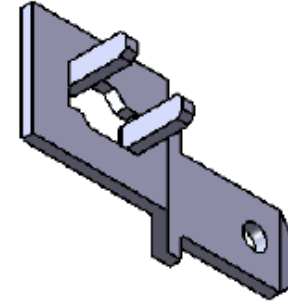
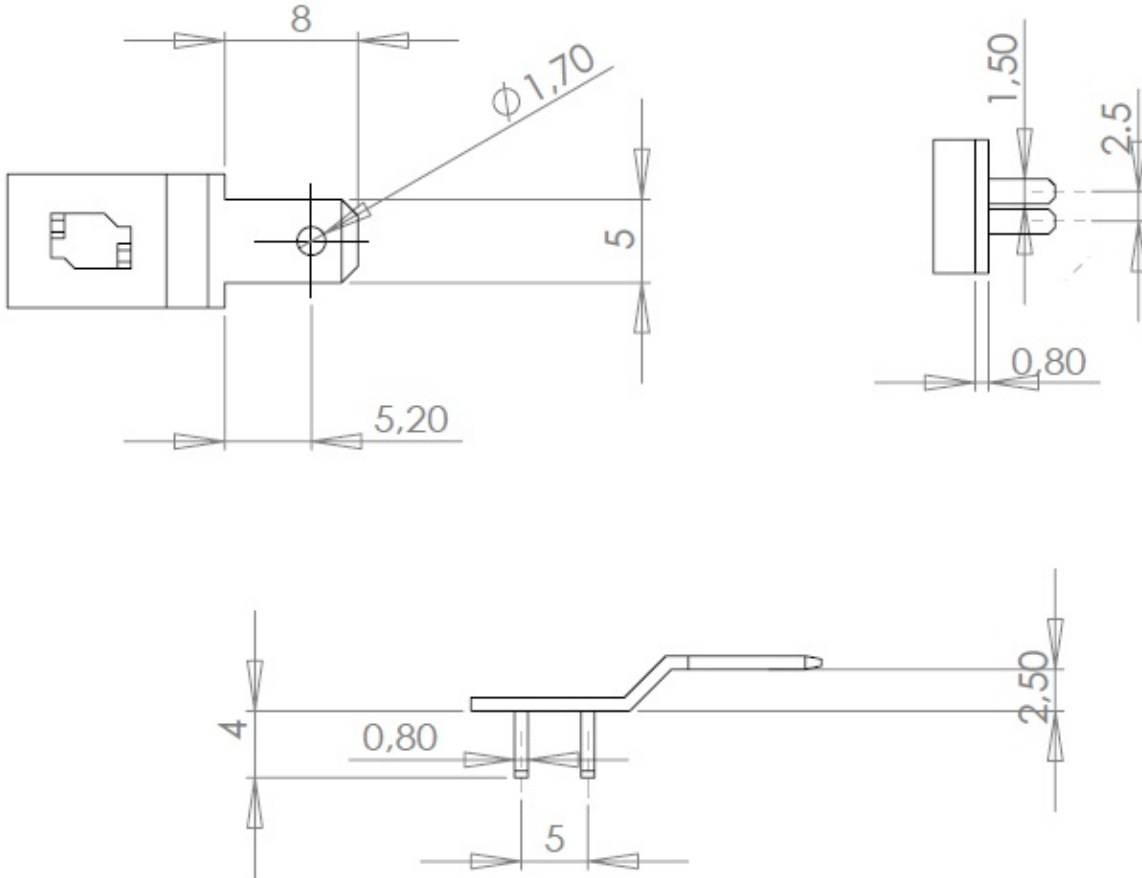

Material

L = RoHS tinned brass • A = RoHS tinned steel