

Y299L - Y299A

MFOM Terminals - Terminals for printed circuits - 2,8 x 0,8

 Buy this product online

www.mfom.fr

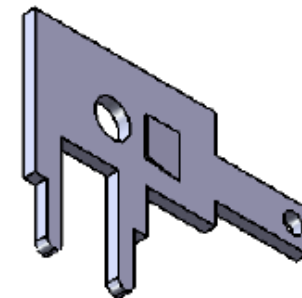
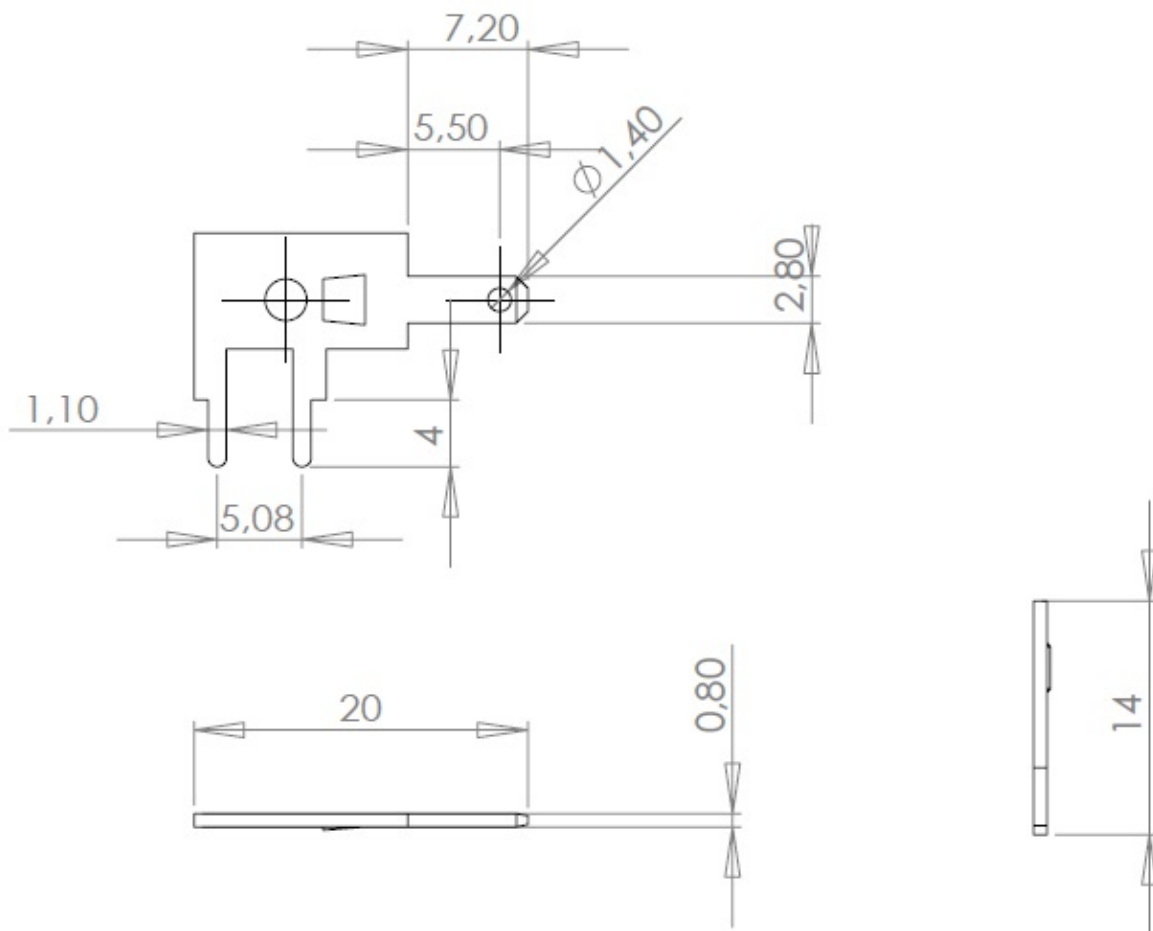

Material

L = RoHS tinned brass • A = RoHS tinned steel