

Y 308 L

MFOM Terminals - Terminals for printed circuits - 2,8 x 0,8

 Buy this product online

www.mfom.fr

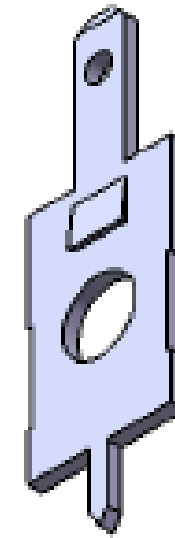
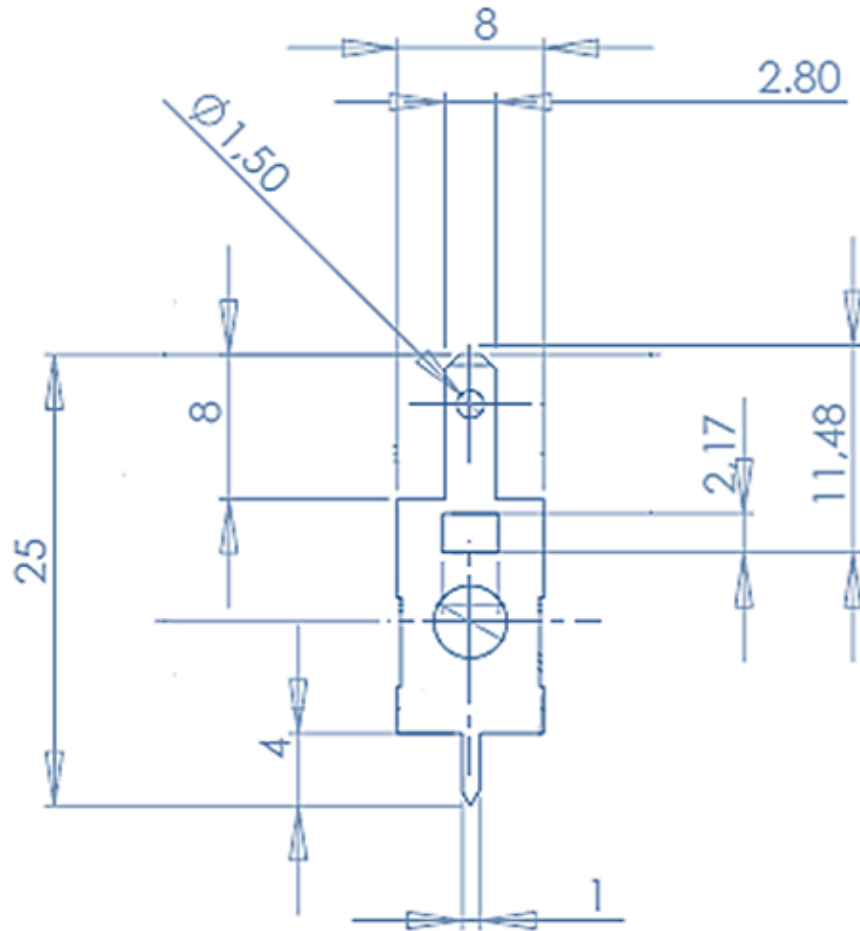

Material

RoHS tinned brass