

Y187L

MFOM Terminals - Terminals for printed circuits - 2,8 x 0,5

 Buy this product online

www.mfom.fr

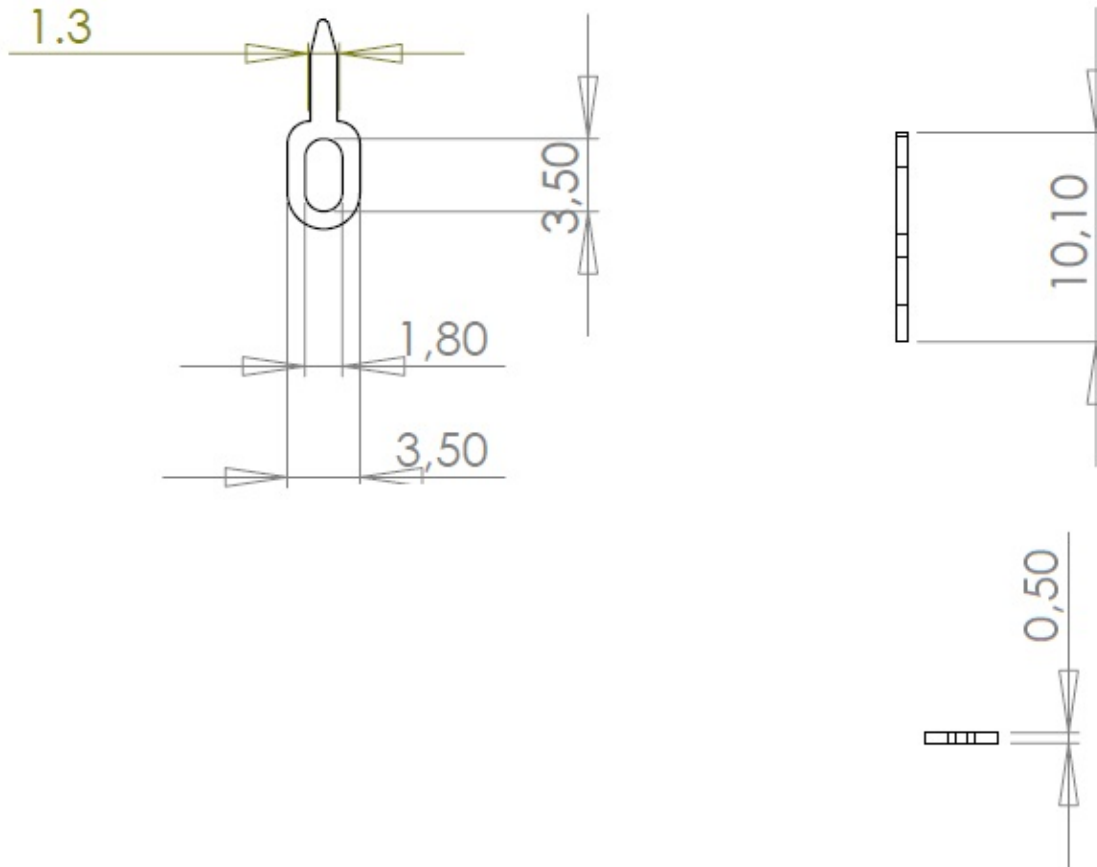

Material

RoHS tinned brass