

# Y307L - Y307A

MFOM Terminals - Terminals for printed circuits - 2,8 x 0,5

 Buy this product online

[www.mfom.fr](http://www.mfom.fr)

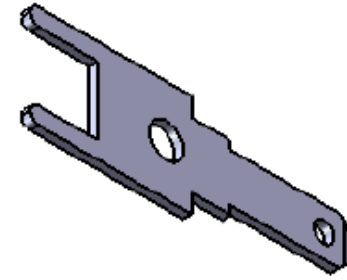
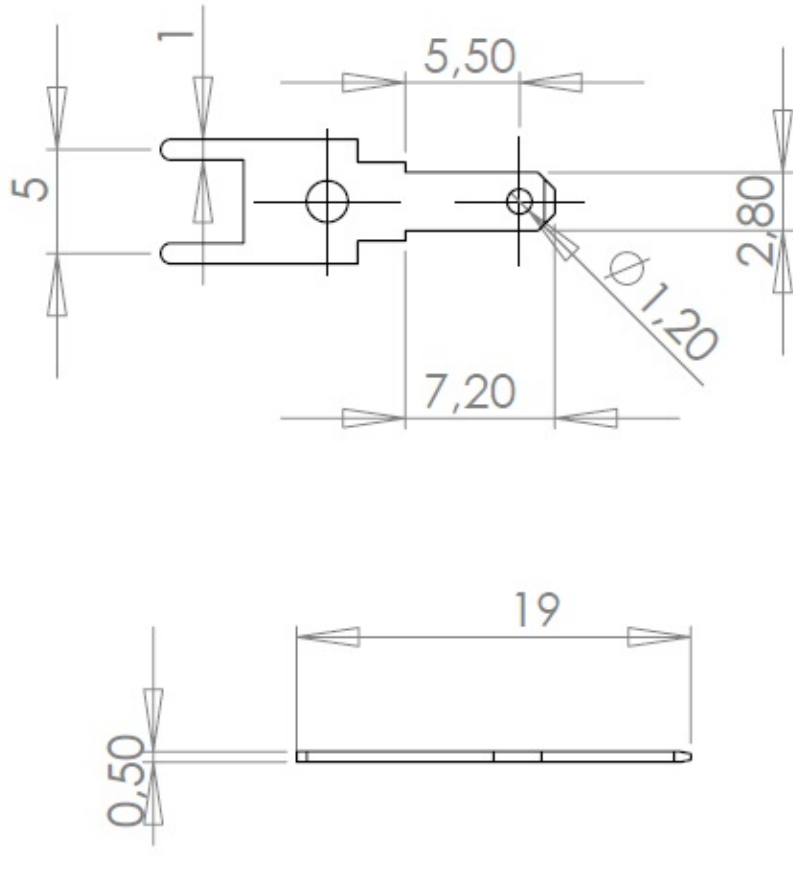

## Material

L = RoHS tinned brass • A = RoHS tinned steel