

Y306L - Y306A

MFOM Terminals - Terminals for printed circuits - 2,8 x 0,5

 Buy this product online

www.mfom.fr

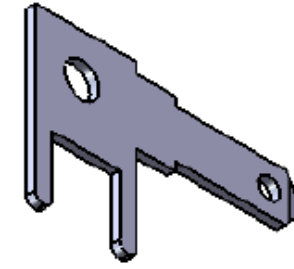
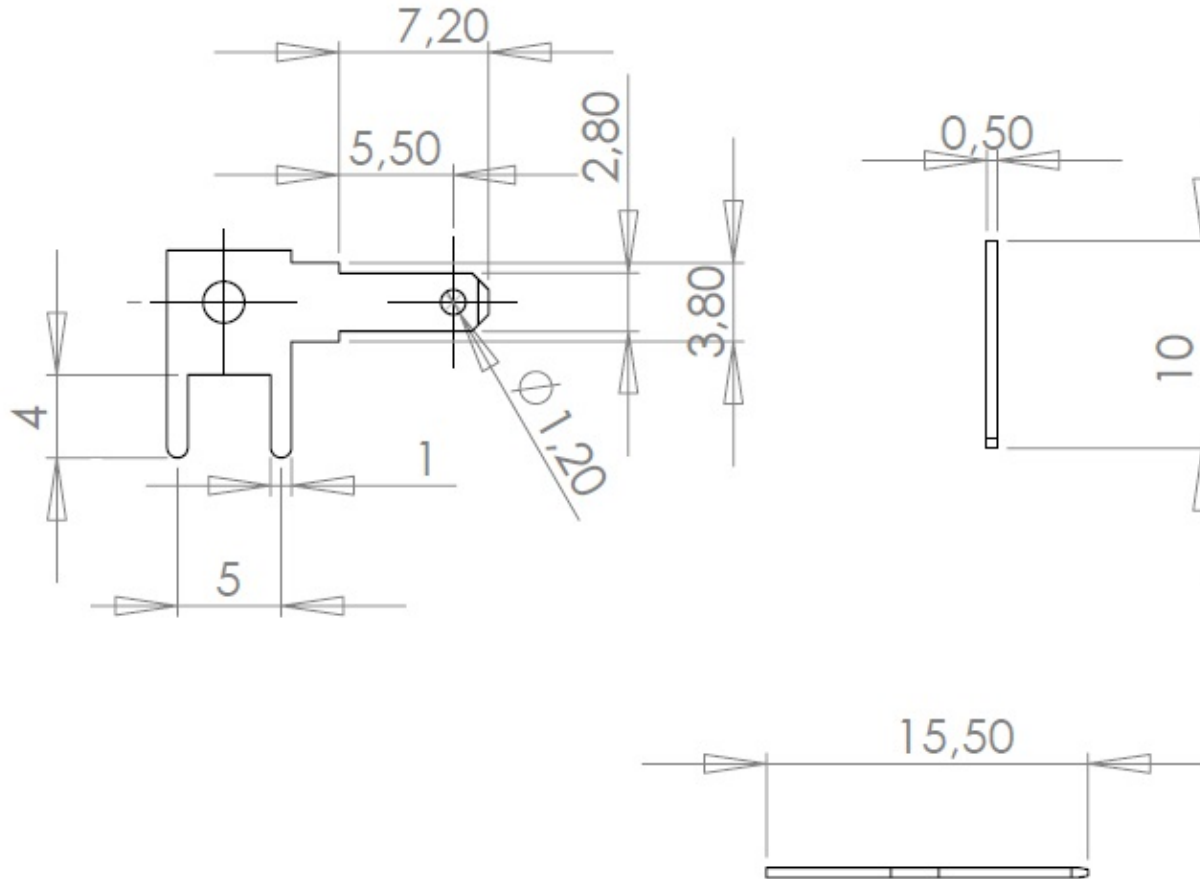

Material

L = RoHS tinned brass • A = RoHS tinned steel