

# Y206L

## MFOM Terminals - Terminals for printed circuits - 2,8 x 0,5

 Buy this product online

[www.mfom.fr](http://www.mfom.fr)

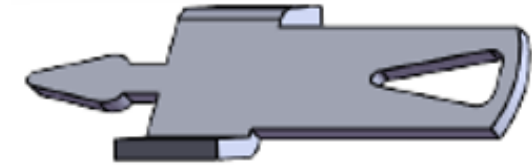
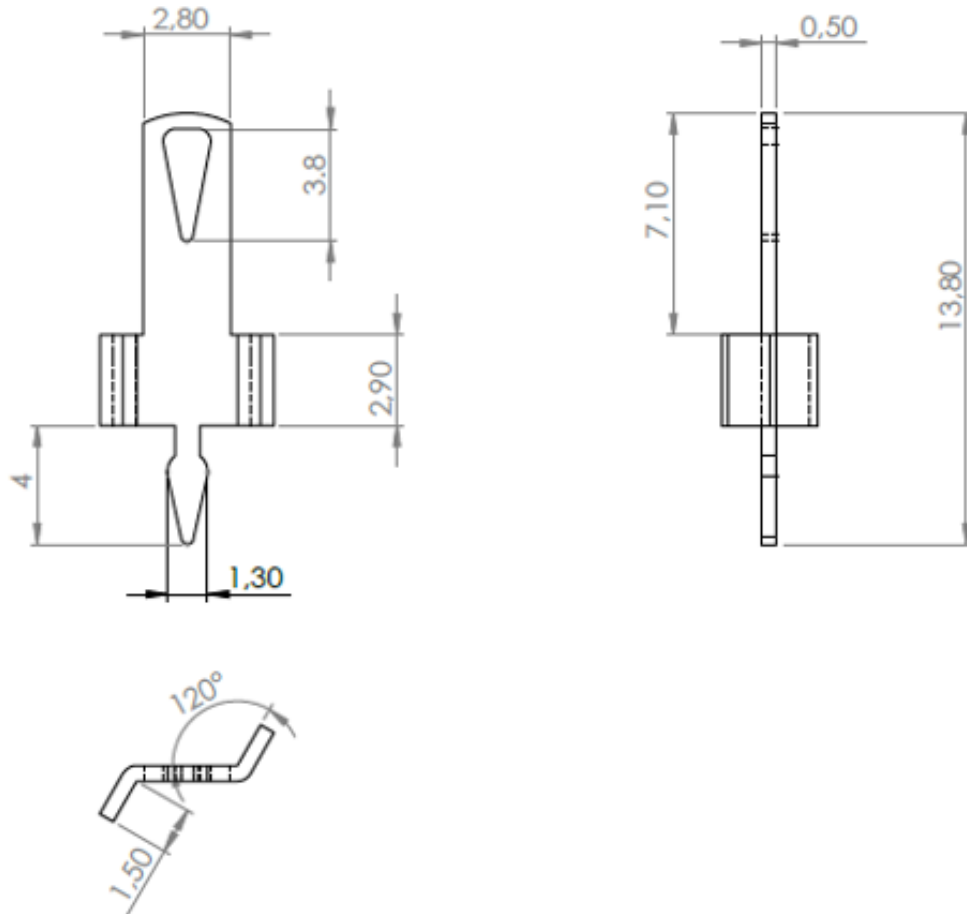

### Material

RoHS tinned brass