

Y304L - Y304A

MFOM Terminals - Terminals for printed circuits - 6,35 x 0,8

 Buy this product online

www.mfom.fr

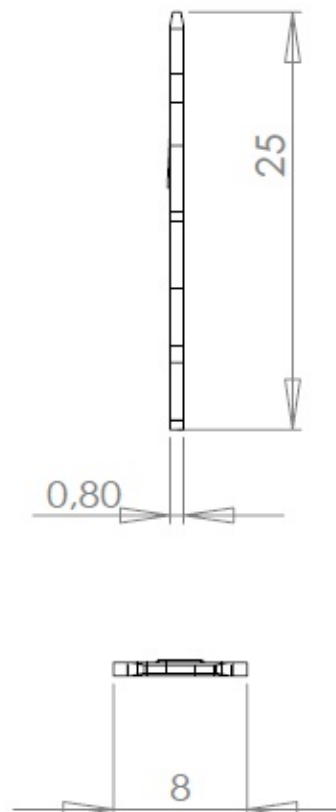
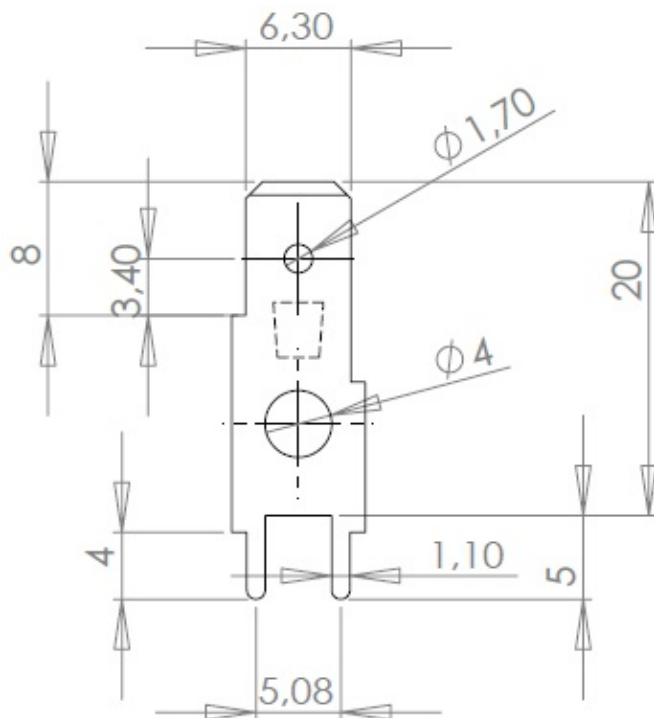

Material

L = RoHS tinned brass • A = RoHS tinned steel