

US 175

Barrier strips - Spacing of 17,46 mm

 Buy this product online

www.mfom.fr

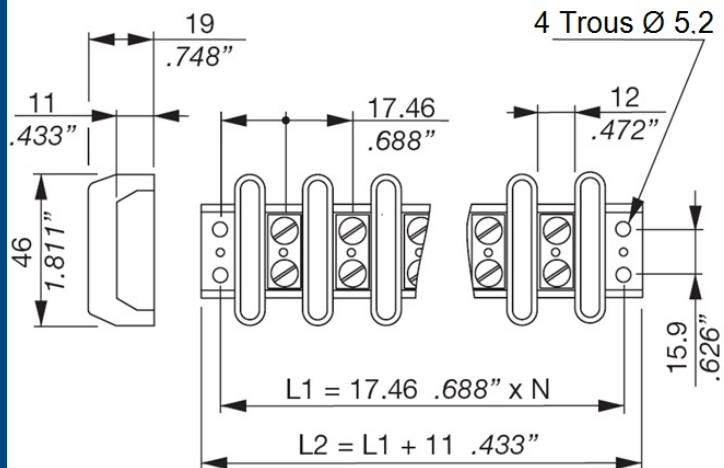

N= nombre de contacts + 1
/ numbers of contacts + 1

Options

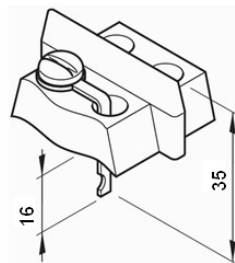

US 176

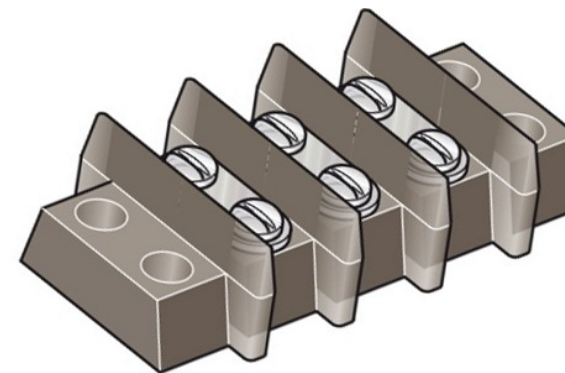

Spacing : 17,46 mm • Number of poles : 2 to 13

Electrical characteristics

Rated voltage : 600 Volts • Rated current : 50 A

Material

Screw : Steel • Terminal : Brass • Insulation body : Thermodur UL 94

Other characteristics

Marking on request • Special mounting on request • Protection cover